

SMD QUARTZ CRYSTAL SPECIFICATION

SERIES „SMD02016/4 26.000 MHZ 10/20/-40+85/8PF“

FEATURES

- + New ultra compact top seller SMD-Crystal in ceramic package
- + High reliability for low cost
- + Our top quality promise / depth of production:
 - Only use of crystal blanks from our in-house production
 - Excellent product features guaranteed by multiple 100% tests
 - 100% quality monitoring from crystal raw material to the end product



GENERAL DATA

PARAMETERS	PRODUCT FEATURES AND CONDITIONS
SMD-CRYSTAL SERIES	SMD02016/4
PACKAGE HEIGHT	0.55 mm max.
FREQUENCY	26.000 MHz
MODE OF VIBRATION	AT-FUNDAMENTAL
EQUIVALENT SERIES RESISTANCE	50 Ω max.
FREQUENCY TOLERANCE AT 25°C	±10 ppm
LOAD CAPACITANCE (CL)	8 pF
WORKING TEMPERATURE RANGE	-40/+85°C
TEMPERATURE STABILITY	±20 ppm over -40/+85°C (referred to +25°C)
SHUNT CAPACITANCE (C ₀)	1 pF max.
AGING	±2 ppm max. after first year, ±10 ppm max. after 10 years
DRIVE LEVEL	100 μW typ. / 200 μW max.
INSULATION RESISTANCE	>500 MΩ DC/100V ±15V
STORAGE TEMPERATURE	-55/+125°C
DELIVERY FORM	Tape & Reel (3.000 pcs)
RoHS	Lead free and RoHS compliant
SOLDERING CONDITION	See reflow solder profile
MARKING	Line 1 = 226WX3 Line 2 = xxxx (xxxx = date code)
ORDERING CODE	SMD02016/4 26.000 MHz 10/20/-40+85/8pF
CUSTOMER P/N	
PETERMANN-TECHNIK P/N	QEU9310107

Note:

1. The reference temperature for all specified values and tests is +25°C.
2. Do not use cleaning baths operating at ultrasonic frequencies or ultrasonic welding processes.

DIMENSIONS

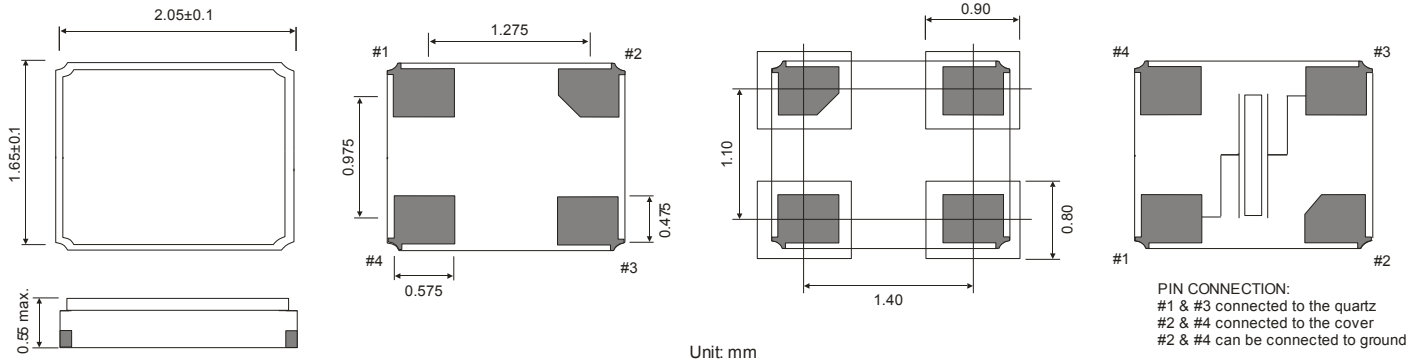

REEL SPECIFICATION

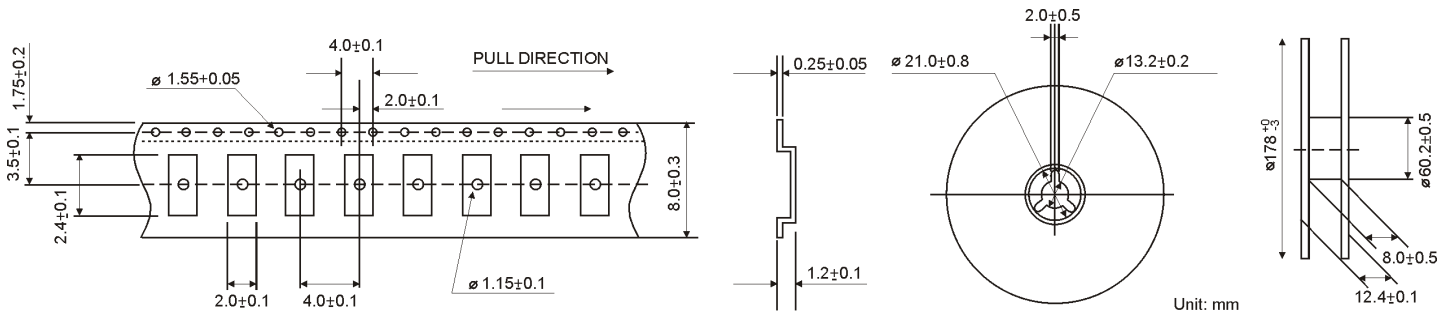

REFLOW SOLDER PROFILE

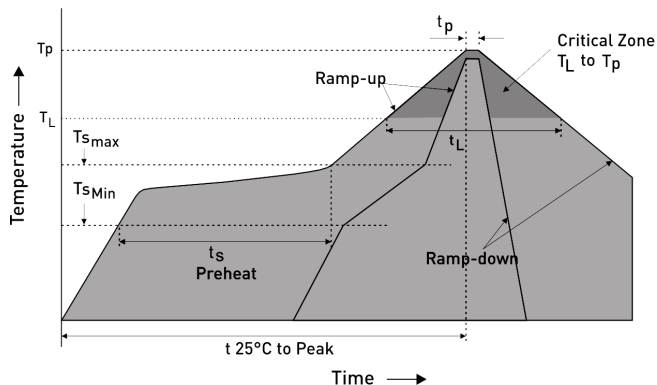

IPC/JEDEC Standard	IPC/JEDEC J-STD-020
Moisture Sensitivity Level	Level 1
TS MAX to TL (Ramp-up Rate)	3°C/second Maximum
Preheat	
- Temperature Minimum (TS MIN)	150°C
- Temperature Typical (TS TYP)	175°C
- Temperature Maximum (TS MAX)	200°C
- Time (tS)	60 - 180 seconds
Ramp-up Rate (TL to TP)	3°C/second Maximum
Time Maintained Above:	
- Temperature (TL)	217°C
- Time (TL)	60 - 150 seconds
Peak Temperature (TP)	265°C Maximum
Target Peak Temperature (TP Target)	255°C
Time within 5°C of actual peak (tP)	20 - 40 seconds
Max. Number of Reflow Cycles	2
Ramp-down Rate	6°C/second Maximum
Time 25°C to Peak Temperature (t)	8 minutes Maximum



PREMIUM QUALITY BY PETERMANN-TECHNIK



OUR COMPANY IS CERTIFIED ACCORDING TO ISO 9001:2015 AND 14001:2015

THIS IS FOR YOU TO ENSURE THAT THE PRINCIPLES OF QUALITY MANAGEMENT ARE FULLY IMPLEMENTED IN OUR QUALITY MANAGEMENT SYSTEM AND QUALITY CONTROL METHODS ALSO DOMINATE OUR QUALITY STANDARDS.